



CYLINDERS

CYLINDER (Pendant) 2", 3", 5" LED DOWNLIGHT (Round & Square)

PROJECT: _____

TYPE: _____

NOTE: _____

SPEC-00281 CYLINDER LP 2" 3" 5", V-1.0, UPDATED 03/04/2024

LP2, LP3, LP5, SLP2, SLP3, SLP5



2" Pendant Cylinder (Round & Square)
with Standard Retro Fit Canopy

3" Pendant Cylinder (Round & Square)
with Standard Retro Fit Canopy

5" Pendant Cylinder (Round & Square)
with Standard Retro Fit Canopy

LED LIGHT ENGINE

RATED WATTAGE	2" (10W-20W), 3" (15W-30W), 5" (15W-50W)
DELIVERED LUMENS	Up to: 2" 1943 lm, 3" 3175 lm, 5" 4975 lm
CCT/CRI	2700K 90CRI, 3000K 90CRI, 4000K 80CRI, WARM DIM 98CRI
COLOR QUALITY	2700K-3500K 90+ CRI, 2-Step SDCM
LED LIFETIME	55,000 hours @ L90

SIZE	MAX POWER	LUMENS @ 3500K			
		10° Optic	30° Optic	50° Optic	80° Optic
2 Inch	20 Watt	1530 lm	1633 lm	1506 lm	1271 lm
3 Inch	30 Watt	2227 lm	2646 lm	2440 lm	2023 lm
5 Inch	50 Watt	3877 lm	4252 lm	4228 lm	2858 lm

CCT MULTIPLIER CHART

SIZE	2700K 90CRI	3000K 90CRI	3500K 90CRI	4000K 80CRI	WARM DIM 98CRI
2 Inch	0.92	0.97	1.00	1.19	0.62
3 Inch	0.91	0.97	1.00	1.20	0.62
5 Inch	0.92	0.96	1.00	1.17	0.57

POWER MULTIPLIER CHART

SIZE	10W	15W	20W	25W	30W	35W	40W	50W
2 Inch	0.60	0.80	1.00					
3 Inch		0.57	0.65	0.78	1.00			
5 Inch		0.37	0.48	0.58	0.68	0.77	0.85	1.00

SILENT VU™ OPTICS TECHNOLOGY

OPTICS	10°, 30°, 50°, 80° Available
ADJUSTABLE	Non Adjustable
MEDIA	Clear, Solite, Frosted, Linear Spread, Hex Louver

POWER SUPPLY

INPUT VOLTAGE	120/277V, 50/60Hz
DIMMING	Multiple Dimming Drivers Available
SERVICABILITY	Light Module and Driver Field Serviceable

STANDARD FINISH

WT (Semi Gloss White) MB (Matte Black)

- All custom finishes available (see finishes sample page)

MOUNTING

- 5" x 1/3" canopy included with standard universal dim driver (7 1/8" x 2 1/4" round canopy or 6 1/4" x 2 1/4" square canopy included with Lutron, EldoLED and DMX Driver options)
- 4' of stem included; (1) 6", (2) 12" & (1) 18" (includes couplers)
- 10' field adjustable cord available
- Standard Driver canopy mounts a 4" round junction box
- Alternative Driver canopy mounts to standard 4" round and square junction boxes

LISTING / WARRANTY

- Five (5) year limited warranty
- cULus Listed for Wet Location
- UL Listed for 40°C Ambient
- CA Title 24-JA8 Compliant



2" PENDANT ORDER MATRIX

2" CYLINDER LED PENDANT (EXAMPLE: LP2-10-27-30-CL-CL-WT-C-5-S-ST)

SHAPE	WATTAGE	CCT/CRI	OPTIC	MEDIA 1	MEDIA 2
LP2 Pendant Downlight 2" Round	-10 (10W)	-27 (2700K 90CRI)	-10 (10° Spot)	(blank) (None)	(blank) (None)
	-15 (15W)	-30 (3000K 90CRI)	-30 (30° Narrow Flood)	CL (Clear Lens)	CL (Clear Lens)
	-20 (20W)	-35 (3500K 90CRI)	-50 (50° Flood)	MP (Solite Lens)	MP (Solite Lens)
SLP2 Pendant Downlight 2" Square		-40 (4000K 80CRI)	-80* (80° Wide Flood)	FR (Frosted Lens)	FR (Frosted Lens)
		-WD* (Warm Dim 98CRI)	<small>*WD with 80 degree optic not CA title 24 compliant.</small>	LS (Linear Spread Lens)	LS (Linear Spread Lens)
		<small>* Media 1 lens required. For WD with 10°, 30°, 50° Optic use MP (Solite Lens). For WD with 80° Optic use FR (Frosted Lens).</small>		HEX (Hex Louver)	Holds 1 Media only when HEX selected
STANDARD FINISH	COASTAL COATING	REVISION	STANDARD DRIVER		
-WT (Semi Gloss White)	(blank) (None)	-5 (Revision)	-S (Universal Dim Driver: 1%-100% 0-10V, TRIAC, ELV, 120V/277V)		
-MB (Matte Black)	-C (Coastal Coating)		ALTERNATIVE DRIVER		
<input type="text"/> <small>(See Page 5 for Color Finish Codes)</small>			-L3 (Lutron Dim Driver: 1%-100% EcoSystem, 120V/277V)		
			-EL1 (EldoLED DALI Dim: 1%-100% DALI, 120V/277V)		
			-EL2 (EldoLED Dim: 0.1%-100% 0-10V, 120V/277V)		
			-DMX (DMX Dim: 1%-100% DMX, 120V/277V)		
<small>NOTE: Ambient temperature rated for 25°C</small>					
HANGING OPTIONS					
-ST (Stem - Retro Fit)					
-NCST (Stem - New Construction)					
-BC (10' Black Cord - Retro Fit)					
-WC (10' White Cord - Retro Fit)					
-NCBC (10' Black Cord - New Construction)					
-NCWC (10' White Cord - New Construction)					

ACCESSORIES (2" CYLINDER)

OPTIC
C2-10-OPTIC (10° Spot)
C2-30-OPTIC (30° Narrow Flood)
C2-50-OPTIC (50° Flood)
C2-80-OPTIC (80° Wide Flood)

MEDIA
C2-CL (Clear Lens)
C2-MP (Solite Lens)
C2-FR (Frosted Lens)
C2-LS (Linear Spread Lens)
C2-HEX (Hex Louver)

EMERGENCY

DRIVER
EM-1000 (25W Remote Inverter)
EM-1002 (10W Remote EM Driver)
EM-1003-CA (35W Remote Inverter) Title 20
EM-1004 (50W Remote Inverter)
EM-1006 (25W Remote Inverter) Title 20

3" PENDANT ORDER MATRIX

3" CYLINDER LED PENDANT (EXAMPLE: LP3-25-35-50-CL-MB-C-6-S-ST)

SHAPE	WATTAGE	CCT/CRI	OPTIC	MEDIA 1	MEDIA 2
LP3 Pendant Downlight 3" Round	-15 (15W)	-27 (2700K 90CRI)	-10 (10° Spot)	(blank) (None)	(blank) (None)
	-20 (20W)	-30 (3000K 90CRI)	-30 (30° Narrow Flood)	CL (Clear Lens)	CL (Clear Lens)
	-25 (25W)	-35 (3500K 90CRI)	-50 (50° Flood)	MP (Solite Lens)	MP (Solite Lens)
SLP3 Pendant Downlight 3" Square	-30 (30W)	-40 (4000K 80CRI)	-80* (80° Wide Flood)	FR (Frosted Lens)	FR (Frosted Lens)
		-WD* (Warm Dim 98CRI)	<small>*WD with 80 degree optic not CA title 24 compliant.</small>	LS (Linear Spread Lens)	LS (Linear Spread Lens)
		<small>* Media 1 lens required. For WD with 10°, 30°, 50° Optic use MP (Solite Lens). For WD with 80° Optic use FR (Frosted Lens).</small>		HEX (Hex Louver)	Holds 1 Media only when HEX selected
STANDARD FINISH	COASTAL COATING	REVISION	STANDARD DRIVER		
-WT (Semi Gloss White)	(blank) (None)	-6 (Revision)	-S (Universal Dim Driver: 1%-100% 0-10V, TRIAC, ELV, 120V/277V)		
-MB (Matte Black)	-C (Coastal Coating)		ALTERNATIVE DRIVER		
<input type="text"/> <small>(See Page 5 for Color Finish Codes)</small>			-L3 (Lutron Dim Driver: 1%-100% EcoSystem, 120V/277V)		
			-EL1 (EldoLED DALI Dim: 1%-100% DALI, 120V/277V)		
			-EL2 (EldoLED Dim: 0.1%-100% 0-10V, 120V/277V)		
			-DMX (DMX Dim: 1%-100% DMX, 120V/277V)		
			<small>NOTE: Ambient temperature rated for 25°C</small>		
HANGING OPTIONS					
-ST (Stem - Retro Fit)					
-NCST (Stem - New Construction)					
-BC (10' Black Cord - Retro Fit)					
-WC (10' White Cord - Retro Fit)					
-NCBC (10' Black Cord - New Construction)					
-NCWC (10' White Cord - New Construction)					

ACCESSORIES (3" CYLINDER)

OPTIC
C3-10-OPTIC (10° Spot)
C3-30-OPTIC (30° Narrow Flood)
C3-50-OPTIC (50° Flood)
C3-80-OPTIC (80° Wide Flood)

MEDIA
C3-CL (Clear Lens)
C3-MP (Solite Lens)
C3-FR (Frosted Lens)
C3-LS (Linear Spread Lens)
C3-HEX (Hex Louver)

EMERGENCY

DRIVER
EM-1000 (25W Remote Inverter)
EM-1002 (10W Remote EM Driver)
EM-1003-CA (35W Remote Inverter) Title 20
EM-1004 (50W Remote Inverter)
EM-1006 (25W Remote Inverter) Title 20

5" PENDANT ORDER MATRIX

5" CYLINDER LED PENDANT (EXAMPLE: LP5-50-WD-80-MP-FR-WT-C-3-S-ST)

SHAPE	WATTAGE	CCT/CRI	OPTIC	MEDIA 1	MEDIA 2
LP5 Pendant Downlight 5" Round	-15 (15W)	-27 (2700K 90CRI)	-10 (10° Spot)	(blank) (None)	(blank) (None)
	-20 (20W)	-30 (3000K 90CRI)	-30 (30° Narrow Flood)	CL (Clear Lens)	CL (Clear Lens)
	-25 (25W)	-35 (3500K 90CRI)	-50 (50° Flood)	MP (Solite Lens)	MP (Solite Lens)
SLP5 Pendant Downlight 5" Square	-30 (30W)	-40 (4000K 80CRI)	-80* (80° Wide Flood) <small>*WD with 80 degree optic not CA title 24 compliant.</small>	FR (Frosted Lens)	FR (Frosted Lens)
	-35 (35W)	-WD* (Warm Dim 98CRI)		LS (Linear Spread Lens)	LS (Linear Spread Lens)
	-40 (40W)	<small>* Media 1 lens required. For WD with 10°, 30°, 50° Optic use MP (Solite Lens). For WD with 80° Optic use FR (Frosted Lens). Warm Dim available up to 30W.</small>	HEX (Hex Louver)	Holds 1 Media only when HEX selected	
	-50 (50W)				
STANDARD FINISH		COASTAL COATING	REVISION	STANDARD DRIVER	
-WT (Semi Gloss White)	(blank) (None)	-C (Coastal Coating)	-3 (Revision)	-S (Universal Dim Driver: 1%-100% 0-10V, TRIAC, ELV, 120V/277V)	
-MB (Matte Black)				ALTERNATIVE DRIVER	
<input type="text"/> <small>(See Page 5 for Color Finish Codes)</small>				-L3 (Lutron Dim Driver: 1%-100% EcoSystem, 120V/277V)	
				-EL1 (EldoLED DALI Dim: 1%-100% DALI, 120V/277V)	
				-EL2 (EldoLED Dim: 0.1%-100% 0-10V, 120V/277V)	
				-DMX (DMX Dim: 1%-100% DMX, 120V/277V)	
<small>NOTE: Ambient temperature rated for 25°C, 50W option not available.</small>					
HANGING OPTIONS					
-ST (Stem - Retro Fit)					
-NCST (Stem - New Construction)					
-BC (10' Black Cord - Retro Fit)					
-WC (10' White Cord - Retro Fit)					
-NCBC (10' Black Cord - New Construction)					
-NCWC (10' White Cord - New Construction)					

ACCESSORIES (5" CYLINDER)

OPTIC
C5-10-OPTIC (10° Spot)
C5-30-OPTIC (30° Narrow Flood)
C5-50-OPTIC (50° Flood)
C5-80-OPTIC (80° Wide Flood)

MEDIA
C5-CL (Clear Lens)
C5-MP (Solite Lens)
C5-FR (Frosted Lens)
C5-LS (Linear Spread Lens)
C5-HEX (Hex Louver)

EMERGENCY

DRIVER
EM-1000 (25W Remote Inverter)
EM-1002 (10W Remote EM Driver)
EM-1003-CA (35W Remote Inverter) Title 20
EM-1004 (50W Remote Inverter)
EM-1006 (25W Remote Inverter) Title 20



CYLINDERS

CYLINDER (Pendant) 2", 3", 5" LED DOWNLIGHT (Round & Square)

PROJECT: _____

TYPE: _____

NOTE: _____

SPEC-00281 CYLINDER LP 2" 3" 5", V-1.0, UPDATED 03/04/2024

LP2, LP3, LP5, SLP2, SLP3, SLP5

STANDARD FINISH

(Stem Mount Shown)



WT

Semi Gloss White



MB

Matte Black

COLOR FINISH

(Stem Mount Shown)



ABL

Aegean Blue



BB

Burnished Bronze



BK

Gloss Black



BLU

Blue



DVG

Dove Gray



FLG

Flannel Gray



GA

Galvanized



GWT

Gloss White



LG

Lime Green



MBL

Midnight Blue



PNA

Painted Natural Aluminum



PNC

Painted Natural Copper



RD

Red



SGR

Sage Green



SND

Sand



SS

Satin Silver



TBZ

Textured Bronze



TGP

Textured Graphite



TNG

Tangerine



TTL

Tahitian Teal



YEL

Yellow



CYLINDERS

CYLINDER (Pendant) 2", 3", 5" LED DOWNLIGHT (Round & Square)

PROJECT: _____

TYPE: _____

NOTE: _____

SPEC-00281 CYLINDER LP 2" 3" 5", V-1.0, UPDATED 03/04/2024

LP2, LP3, LP5, SLP2, SLP3, SLP5

2" ROUND CYLINDER

LP2 (2" Round Cylinder Downlight - Pendant Stem Mount)



STANDARD RETRO FIT
CANOPY

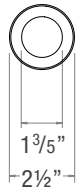
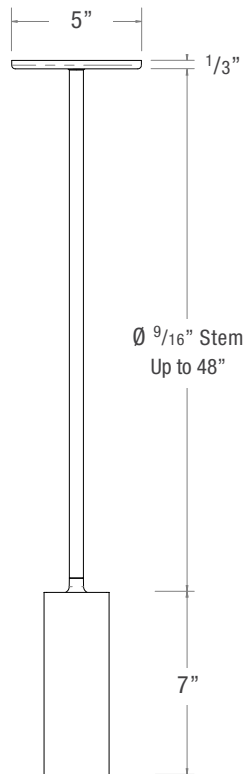

NEW CONSTRUCTION
CANOPY

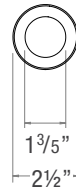
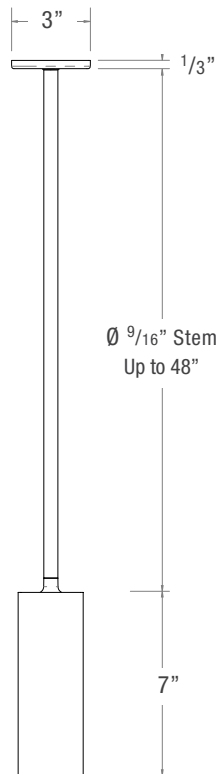

ALTERNATIVE DRIVER
CANOPY

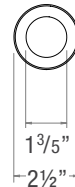
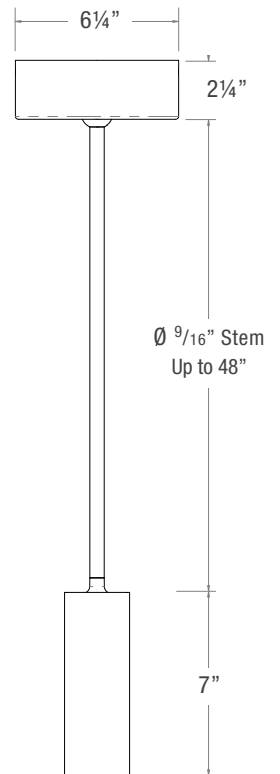



CYLINDERS

CYLINDER (Pendant)
2", 3", 5" LED DOWNLIGHT
(Round & Square)

PROJECT: _____

TYPE: _____

NOTE: _____

SPEC-00281 CYLINDER LP 2" 3" 5", V-1.0, UPDATED 03/04/2024

LP2, LP3, LP5, SLP2, SLP3, SLP5

2" ROUND CYLINDER

LP2 (2" Round Cylinder Downlight - Pendant Cord Mount)



STANDARD RETRO FIT
CANOPY

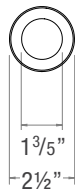
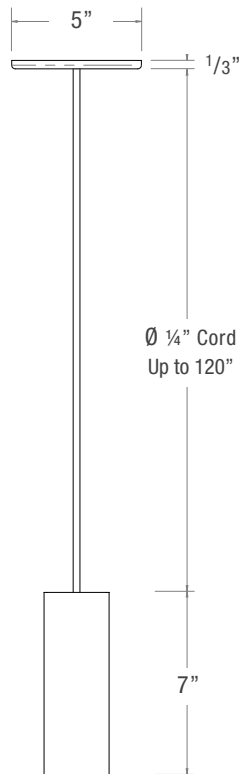

NEW CONSTRUCTION
CANOPY

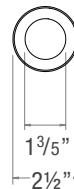
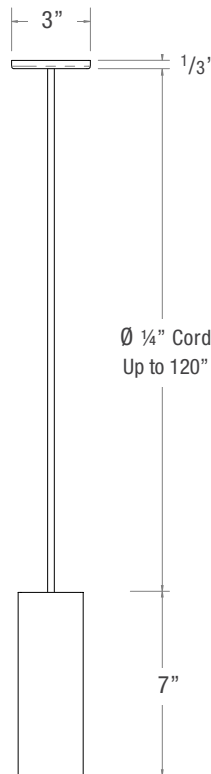

ALTERNATIVE DRIVER
CANOPY

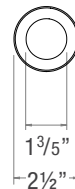
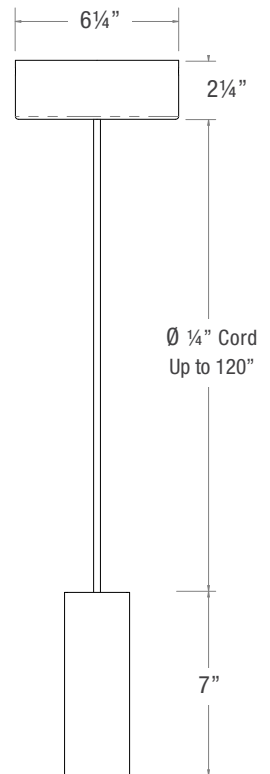



CYLINDERS

CYLINDER (Pendant)
2", 3", 5" LED DOWNLIGHT
(Round & Square)

PROJECT: _____

TYPE: _____

NOTE: _____

SPEC-00281 CYLINDER LP 2" 3" 5", V-1.0, UPDATED 03/04/2024

LP2, LP3, LP5, SLP2, SLP3, SLP5

2" SQUARE CYLINDER

SLP2 (2" Square Cylinder Downlight - Pendant Stem Mount)



STANDARD RETRO FIT
CANOPY

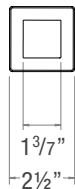
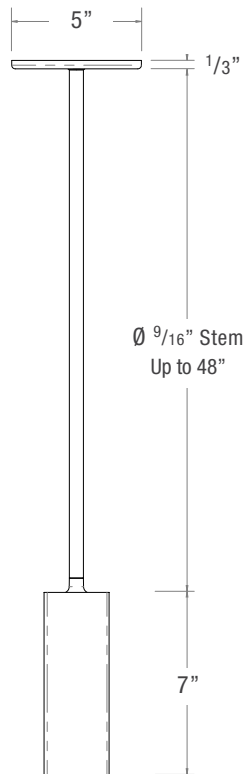

NEW CONSTRUCTION
CANOPY

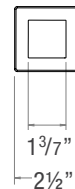
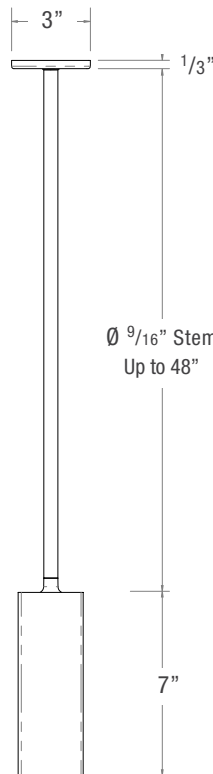

ALTERNATIVE DRIVER
CANOPY

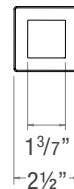
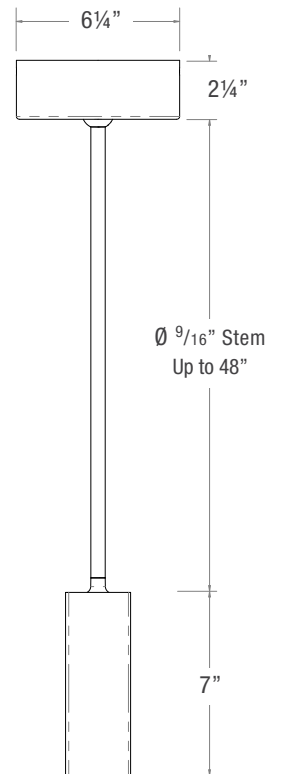



CYLINDERS

CYLINDER (Pendant)
2", 3", 5" LED DOWNLIGHT
(Round & Square)

PROJECT: _____

TYPE: _____

NOTE: _____

SPEC-00281 CYLINDER LP 2" 3" 5", V-1.0, UPDATED 03/04/2024

LP2, LP3, LP5, SLP2, SLP3, SLP5

2" SQUARE CYLINDER

SLP2 (2" Square Cylinder Downlight - Pendant Cord Mount)



STANDARD RETRO FIT
CANOPY

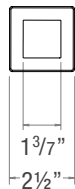
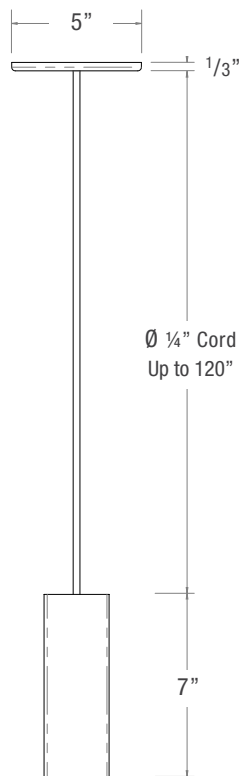

NEW CONSTRUCTION
CANOPY

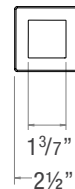
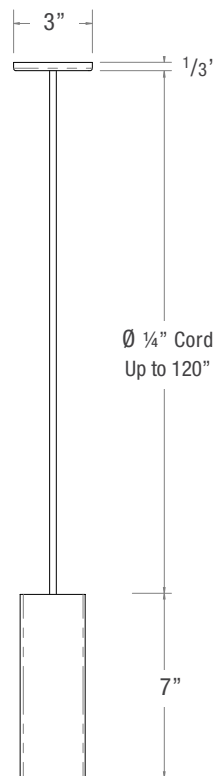

ALTERNATIVE DRIVER
CANOPY

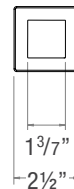
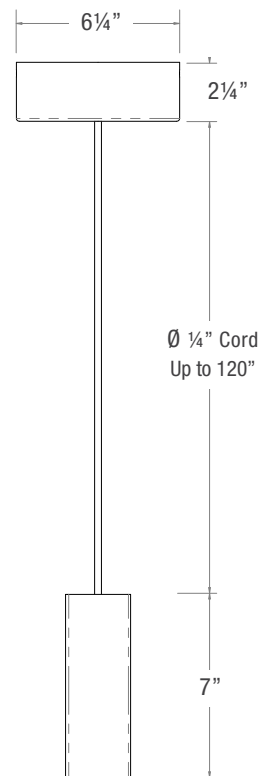



CYLINDERS

**CYLINDER (Pendant)
2", 3", 5" LED DOWNLIGHT
(Round & Square)**

PROJECT: _____

TYPE: _____

NOTE: _____

SPEC-00281 CYLINDER LP 2" 3" 5", V-1.0, UPDATED 03/04/2024

LP2, LP3, LP5, SLP2, SLP3, SLP5

3" ROUND CYLINDER

LP3 (3" Round Cylinder Downlight - Pendant Stem Mount)



STANDARD RETRO FIT
CANOPY

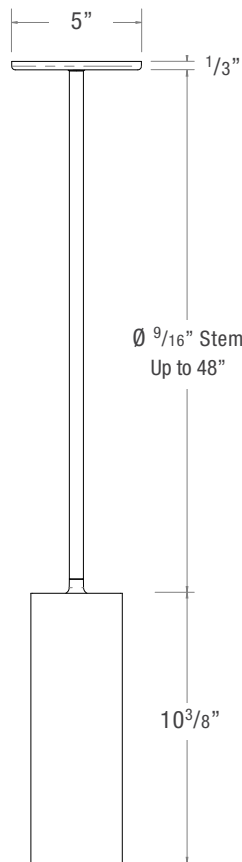

NEW CONSTRUCTION
CANOPY

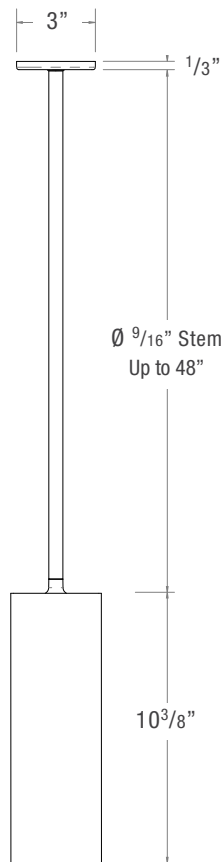

ALTERNATIVE DRIVER
CANOPY

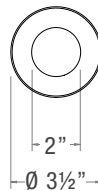
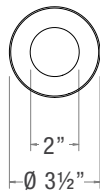
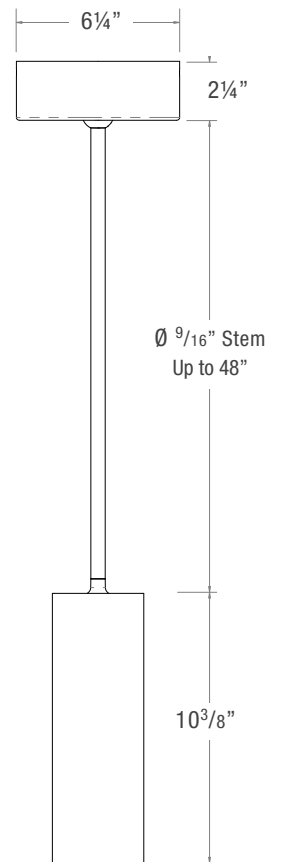



CYLINDERS

CYLINDER (Pendant) 2", 3", 5" LED DOWNLIGHT (Round & Square)

PROJECT: _____

TYPE: _____

NOTE: _____

SPEC-00281 CYLINDER LP 2" 3" 5", V-1.0, UPDATED 03/04/2024

LP2, LP3, LP5, SLP2, SLP3, SLP5

3" ROUND CYLINDER

LP3 (3" Round Cylinder Downlight - Pendant Cord Mount)



STANDARD RETRO FIT
CANOPY

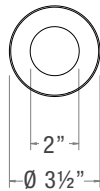
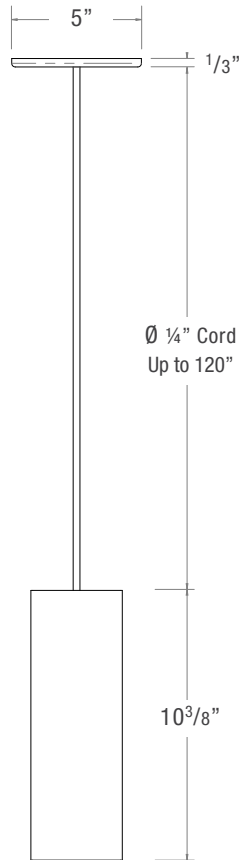

NEW CONSTRUCTION
CANOPY

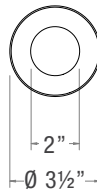
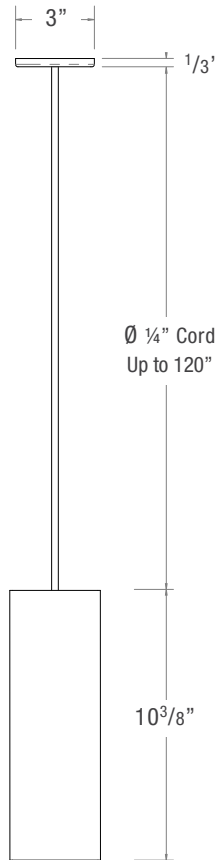

ALTERNATIVE DRIVER
CANOPY

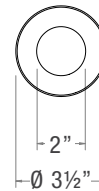
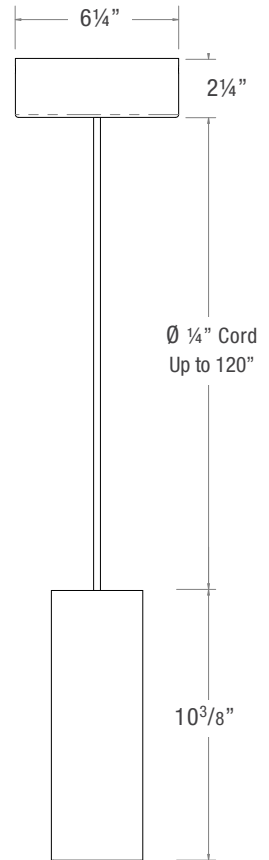



CYLINDERS

CYLINDER (Pendant) 2", 3", 5" LED DOWNLIGHT (Round & Square)

PROJECT: _____

TYPE: _____

NOTE: _____

SPEC-00281 CYLINDER LP 2" 3" 5", V-1.0, UPDATED 03/04/2024

LP2, LP3, LP5, SLP2, SLP3, SLP5

3" SQUARE CYLINDER

SLP3 (3" Square Cylinder Downlight - Pendant Stem Mount)



STANDARD RETRO FIT
CANOPY

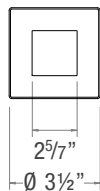
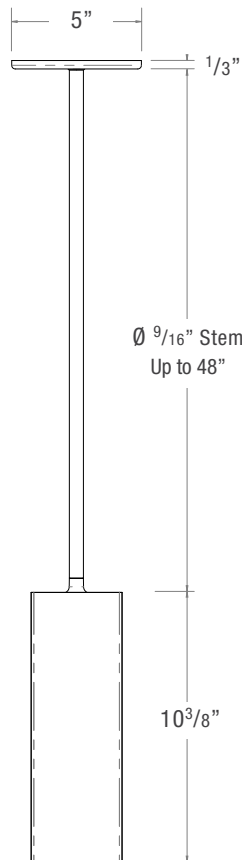

NEW CONSTRUCTION
CANOPY

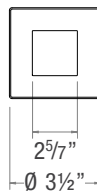
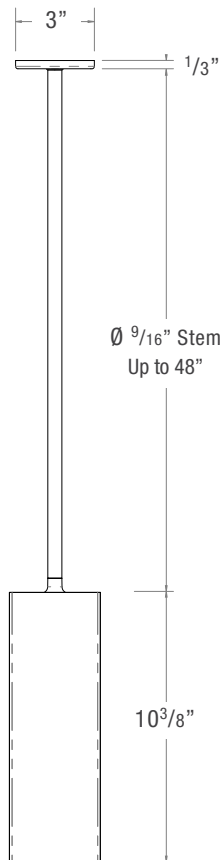

ALTERNATIVE DRIVER
CANOPY

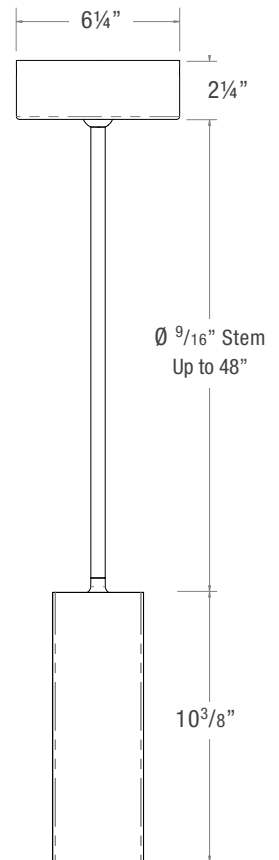



CYLINDERS

CYLINDER (Pendant) 2", 3", 5" LED DOWNLIGHT (Round & Square)

PROJECT: _____

TYPE: _____

NOTE: _____

SPEC-00281 CYLINDER LP 2" 3" 5", V-1.0, UPDATED 03/04/2024

LP2, LP3, LP5, SLP2, SLP3, SLP5

3" SQUARE CYLINDER

SLP3 (3" Square Cylinder Downlight - Pendant Cord Mount)



STANDARD RETRO FIT
CANOPY

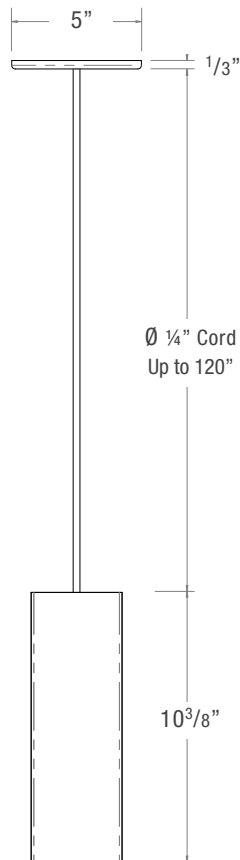

NEW CONSTRUCTION
CANOPY

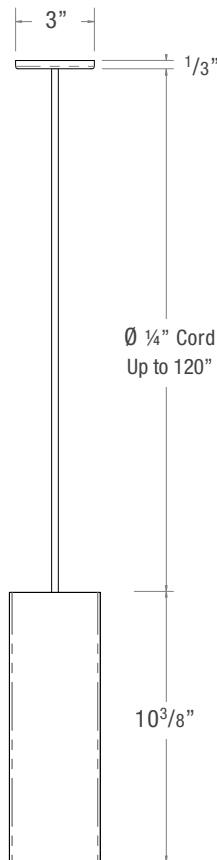

ALTERNATIVE DRIVER
CANOPY

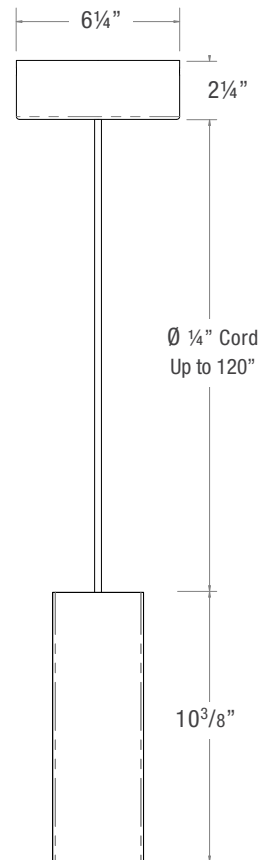

5" ROUND CYLINDER

LP5 (5" Round Cylinder Downlight - Pendant Stem Mount)



STANDARD RETRO FIT
CANOPY

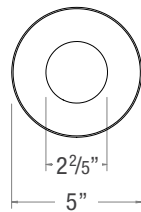
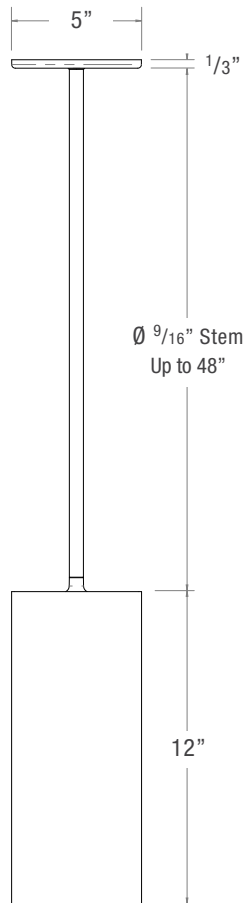

NEW CONSTRUCTION
CANOPY

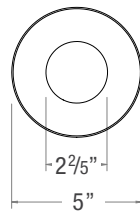
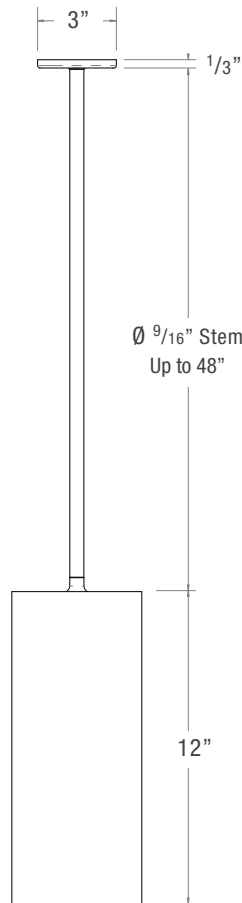

ALTERNATIVE DRIVER
CANOPY

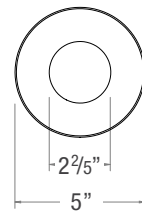
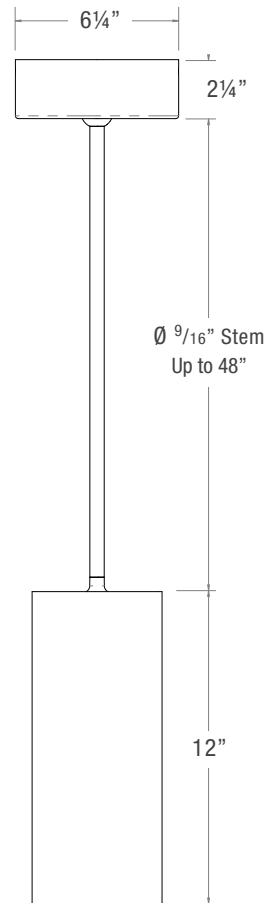

5" ROUND CYLINDER

LP5 (5" Round Cylinder Downlight - Pendant Cord Mount)



STANDARD RETRO FIT
CANOPY

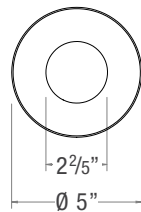
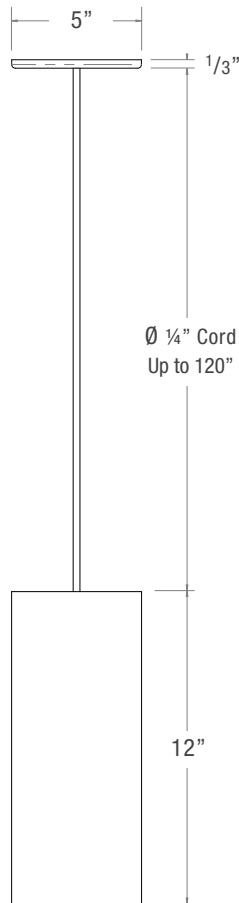

NEW CONSTRUCTION
CANOPY

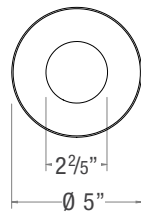
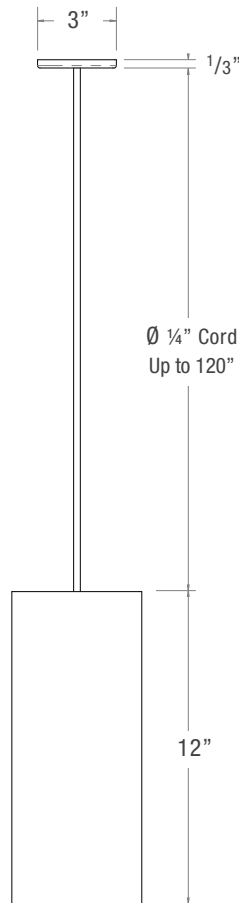

ALTERNATIVE DRIVER
CANOPY

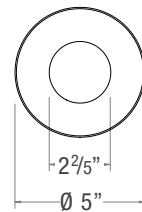
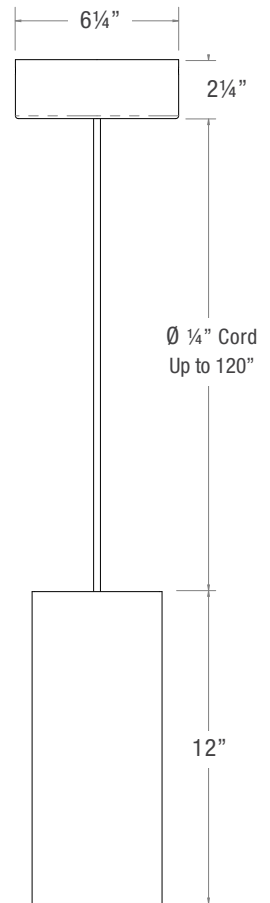

5" SQUARE CYLINDER

SLP5 (5" Square Cylinder Downlight - Pendant Stem Mount)



STANDARD RETRO FIT
CANOPY

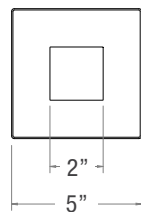
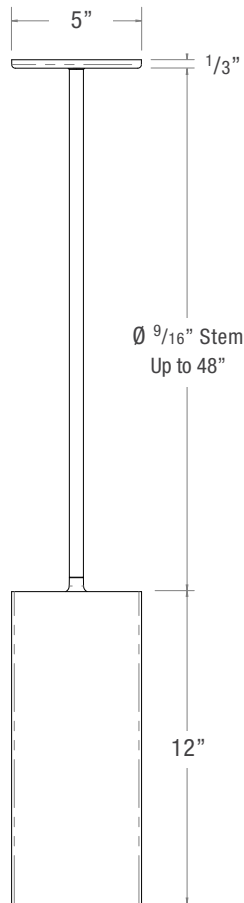

NEW CONSTRUCTION
CANOPY

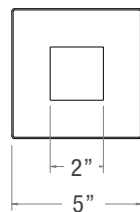
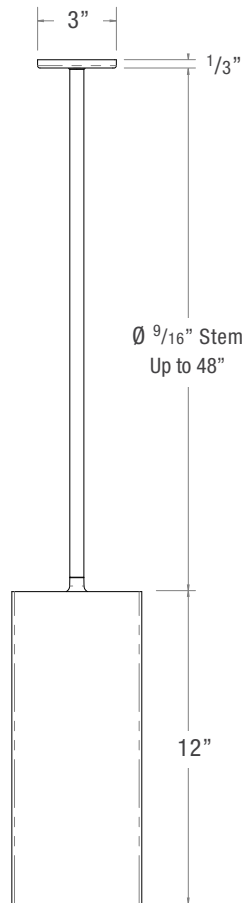

ALTERNATIVE DRIVER
CANOPY

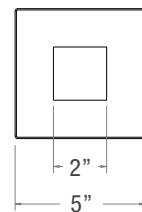
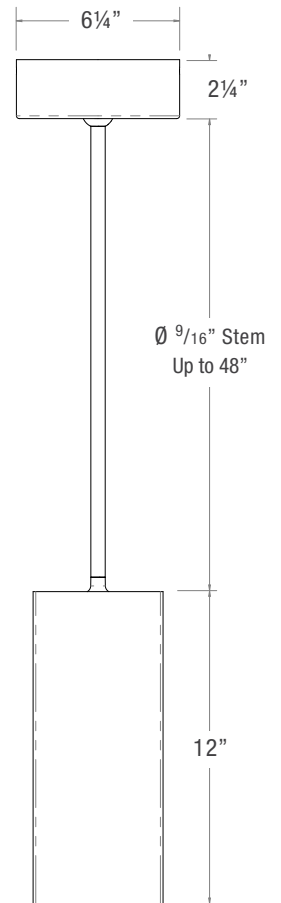

5" SQUARE CYLINDER

SLP5 (5" Square Cylinder Downlight - Pendant Cord Mount)



STANDARD RETRO FIT
CANOPY

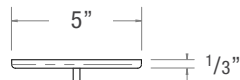

Ø ¼" Cord
Up to 120"

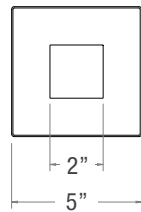
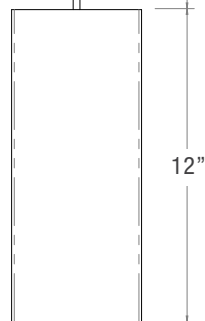

NEW CONSTRUCTION
CANOPY

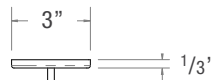

Ø ¼" Cord
Up to 120"

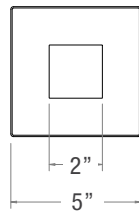
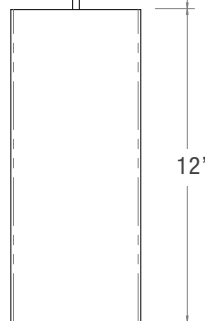

ALTERNATIVE DRIVER
CANOPY

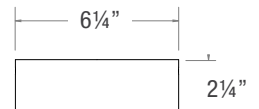

Ø ¼" Cord
Up to 120"

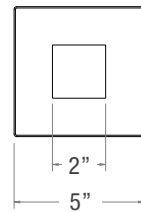
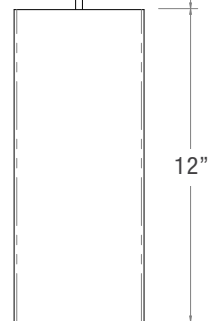

HANGING OPTION (Round Stem Mount)



ST
 Standard Retro Fit
 Stem



NCST
 New Construction
 Stem



Alternative Driver
 Stem

HANGING OPTION (Round Cord Mount)



WC
 Retro Fit
 White Cord

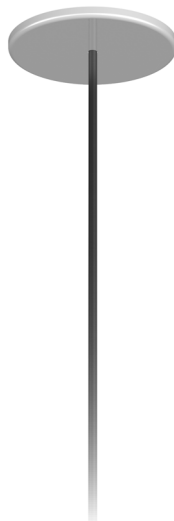

BC
 Retro Fit
 Black Cord



NCWC
 New Construction
 White Cord



NCBC
 New Construction
 Black Cord



Alternative Driver
 White Cord

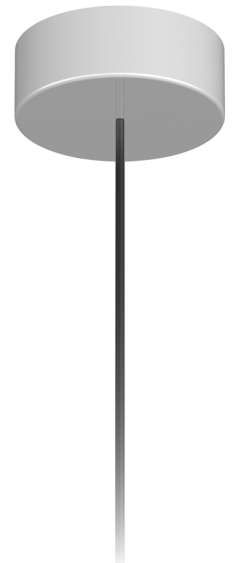

Alternative Driver
 Black Cord

HANGING OPTION (Square Stem Mount)



ST
 Retro Fit
 Stem



NCST
 New Construction
 Stem



Alternative Driver
 Stem

HANGING OPTION (Square Cord Mount)



WC
 Retro Fit
 White Cord



BC
 Retro Fit
 Black Cord



NCWC
 New Construction
 White Cord



NCBC
 New Construction
 Black Cord



Alternative Driver
 White Cord

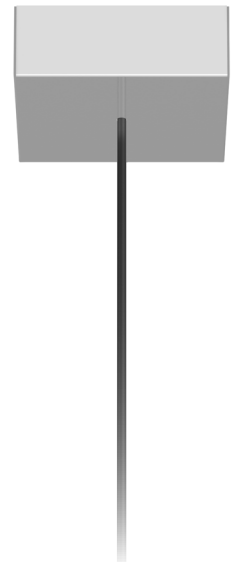

Alternative Driver
 Black Cord

2" PHOTOMETRICS

2" Cylinder (2700K, 90 CRI, 20W)
10° Optic

Polar Plot

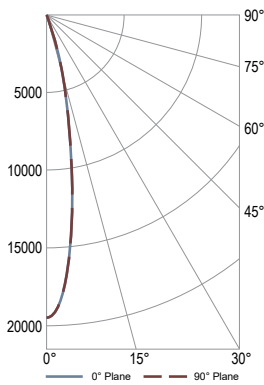

Cone of Light Tabulation

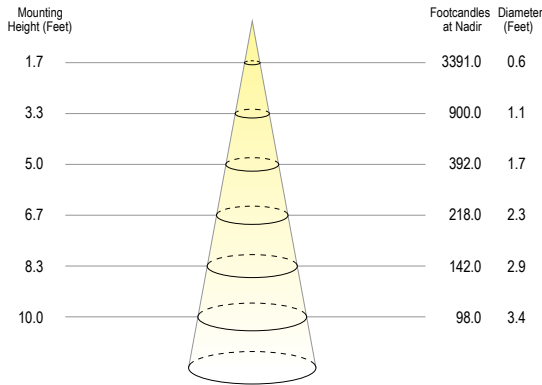

Voltage	Current	Power
119.97 VAC	0.17945 A	21.38 W

Power Factor	Frequency	Current THD
0.993	60 Hz	9.3%

Summary of Results

Spacing Criteria 0-180: 0.34
90-270: 0.34
Total Lumen Output: 1407.3 Lumens
Luminaire Efficacy: 65.8 lm/w
Maximum Candela: 9800 Candela

Zone	Lumens	% of Luminaire
0-40	1404.2	98.8%
0-60	1417.42	99.7%
0-90	1421.67	100.0%

2" Cylinder (2700K, 90 CRI, 20W)
30° Optic

Polar Plot

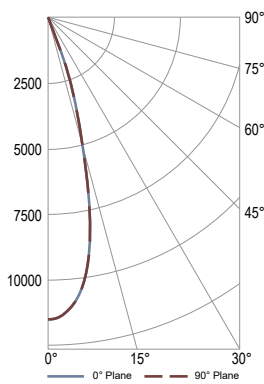

Cone of Light Tabulation

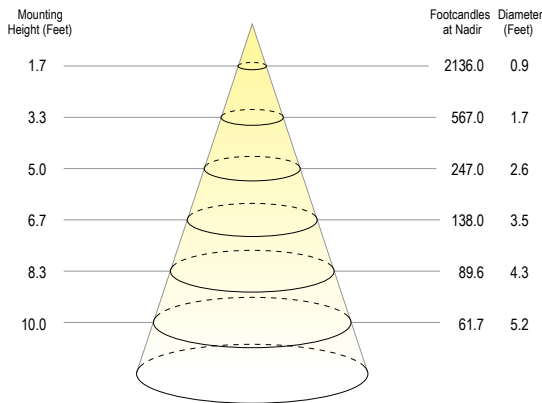

Voltage	Current	Power
119.97 VAC	0.1796 A	21.4 W

Power Factor	Frequency	Current THD
0.993	60 Hz	9.2%

Summary of Results

Spacing Criteria 0-180: 0.50
90-270: 0.50
Total Lumen Output: 1501.9 Lumens
Luminaire Efficacy: 70.2 lm/w
Maximum Candela: 6174 Candela

Zone	Lumens	% of Luminaire
0-40	1493.77	98.9%
0-60	1507.81	99.8%
0-90	1510.9	100.0%

2" PHOTOMETRICS

2" Cylinder (2700K, 90 CRI, 20W) 50° Optic

Polar Plot

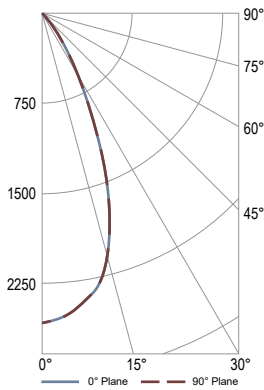

Cone of Light Tabulation

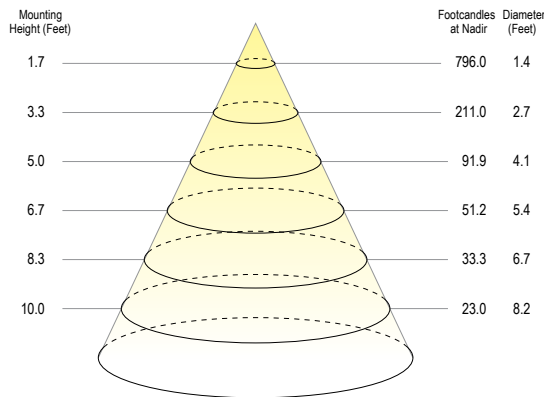

Voltage	Current	Power
119.97 VAC	0.1796 A	21.41 W

Power Factor	Frequency	Current THD
0.993	60 Hz	9.1%

Summary of Results

Spacing Criteria **Total Lumen Output:** 1385.6 Lumens
 0-180: 0.72 **Luminaire Efficacy:** 64.7 lm/w
 90-270: 0.74 **Maximum Candela:** 2297 Candela

Zone	Lumens	% of Luminaire
0-40	1310.37	94.4%
0-60	1384.27	99.7%
0-90	1385.6	100.0%

2" Cylinder (2700K, 90 CRI, 20W) 80° Optic

Polar Plot

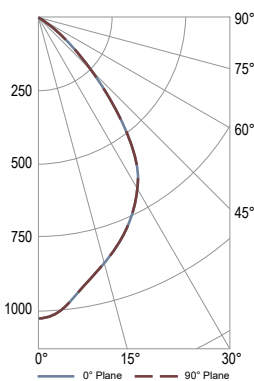

Cone of Light Tabulation

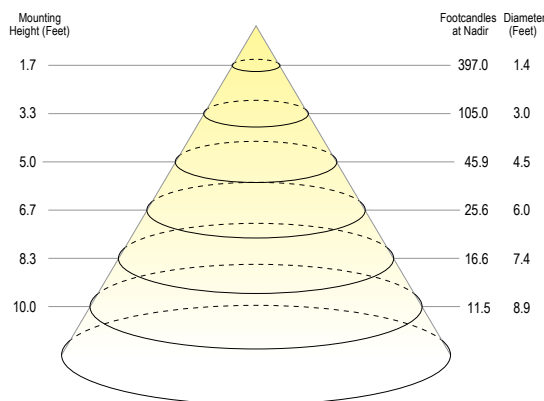

Voltage	Current	Power
119.97 VAC	0.1795 A	21.39 W

Power Factor	Frequency	Current THD
0.993	60 Hz	9.1%

Summary of Results

Spacing Criteria **Total Lumen Output:** 1170 Lumens
 0-180: 1.36 **Luminaire Efficacy:** 57 lm/w
 90-270: 1.38 **Maximum Candela:** 755 Candela

Zone	Lumens	% of Luminaire
0-40	903.62	77.2%
0-60	1157.25	98.9%
0-90	1170	100.0%



CYLINDERS

**CYLINDER (Pendant)
2", 3", 5" LED DOWNLIGHT
(Round & Square)**

PROJECT: _____

TYPE: _____

NOTE: _____

SPEC-00281 CYLINDER LP 2" 3" 5", V-1.0, UPDATED 03/04/2024

LP2, LP3, LP5, SLP2, SLP3, SLP5

DIMMING DRIVER COMPATIBILITY

DIMMER LIST

"S" Standard Universal Dim			
Compatible Phase Cut Dimmer		Compatible 1-10V Dimmer	
Manufacturer	Product	Manufacturer	Product
Cooper	DAL06P	Leviton	IP740-DLZ
	DLC03P	Lightolier	ZP600FAM120
	SLC03P		V2000FAMU
Leviton	6161	Lutron	DVTV
	6631-2		NTFTV
	6633-P	Crestron	CLS-EXP-DIMFLV
	6673-10W		DIN-4DIMFLV4
	6683-IW		DIN-A08
	IPE04		GLX-DIMFLV8
	IPI06-1LZ		
	VPE06		
	Lightolier	ZP26QEW	
	Lutron	CT103P	
DV600P			
DVCL-153P			
DVEL303P			
FAELV500			
LG600P			
MAELV600			
S600P			
S-603PG			
SELV300P			
TG-600P			
	TGCL-153P		

DIMMING DRIVER COMPATIBILITY

DIMMER LIST

"L3" Lutron Fade-to-Black	
Manufacturer	Product
Lutron	LQSE-2ECO-D
	RMJ-ECO32-DV-B
	FCJ/FCJS-ECO
	QSN-1ECO-S
	QSN-2ECO-S
	EcoSystem ESN
	Grafik Eye QS with EcoSystem
	Quantum

NOTES:

Wiring diagrams are examples of typical installations intended to illustrate the number of wires that must be run to fixture. These diagrams are not intended to specify all equipment necessary for a given dimming circuit. Refer to specific dimmer manufacturer's documentation for details.

**L3- LUTRON FADE-TO-BLACK DRIVER
EcoSystem DIMMING**

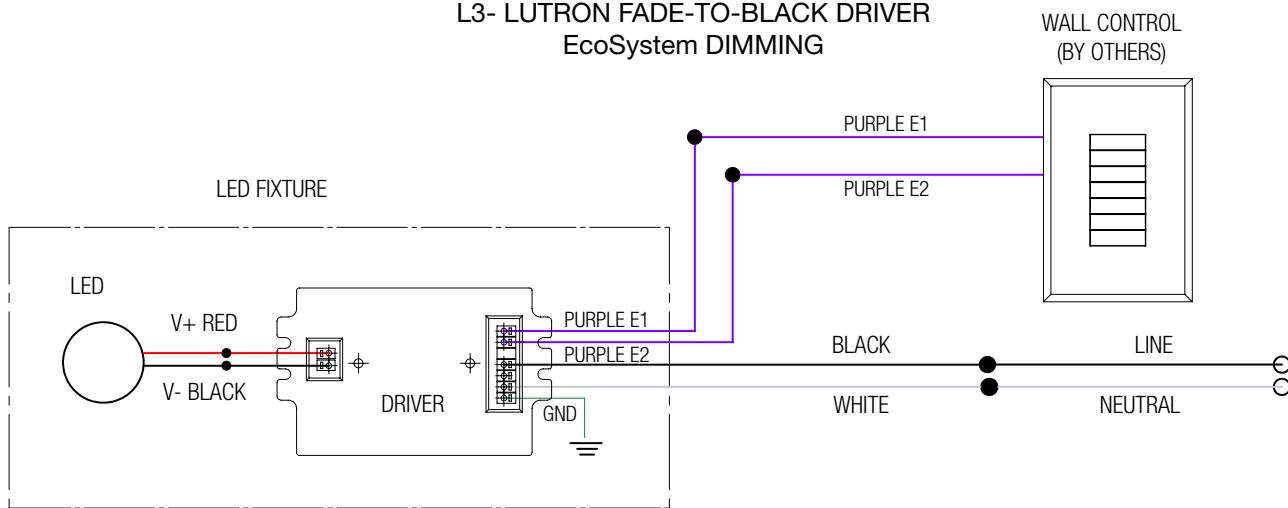

IMPORTANT SAFETY INSTRUCTIONS

- SAVE THESE INSTRUCTIONS

1. Keep these instructions in a safe place for future reference.
2. Only qualified electricians in accordance to local codes should install these fixtures.
3. De-energize the electrical circuit at the circuit breaker prior to installation process or servicing.
4. Make sure all connections are in accordance with the National Electrical Code and any local regulations.
5. Cap any wires not used separately (not together).

DIMMING DRIVER COMPATIBILITY

DIMMER LIST

"EL1" EldoLED DALI 1%	
Manufacturer	Product
	DALI Controls

NOTES:

Wiring diagrams are examples of typical installations intended to illustrate the number of wires that must be run to fixture. These diagrams are not intended to specify all equipment necessary for a given dimming circuit. Refer to specific dimmer manufacturer's documentation for details.

EL1- EldoLED DRIVER DALI DIMMING

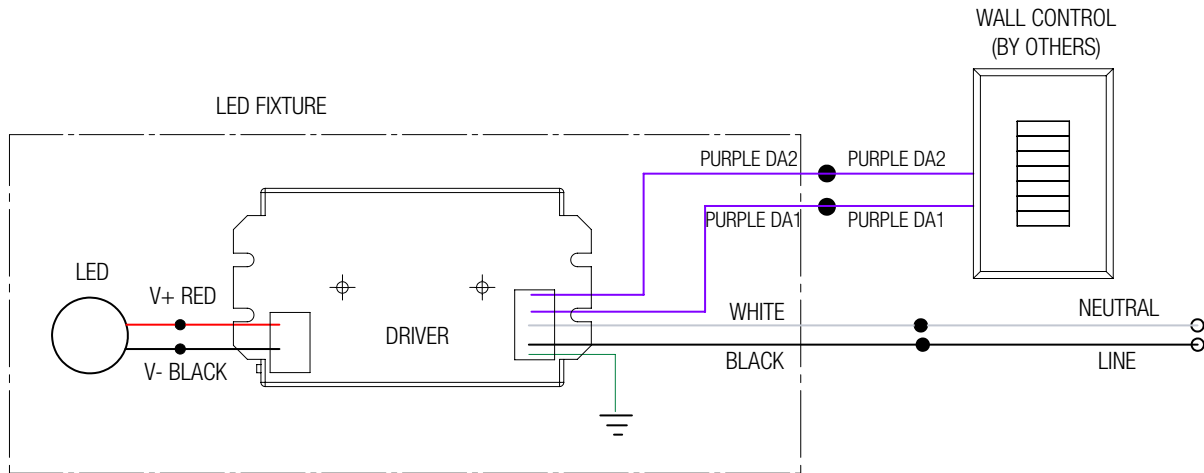

IMPORTANT SAFETY INSTRUCTIONS

- SAVE THESE INSTRUCTIONS

1. Keep these instructions in a safe place for future reference.
2. Only qualified electricians in accordance to local codes should install these fixtures.
3. De-energize the electrical circuit at the circuit breaker prior to installation process or servicing.
4. Make sure all connections are in accordance with the National Electrical Code and any local regulations.
5. Cap any wires not used separately (not together).

DIMMING DRIVER COMPATIBILITY

DIMMER LIST

"EL2" EldoLED 0-10V 1%	
Manufacturer	Product
Leviton	IP740-DLX
Lightolier	ZP600FAM120
Lutron	DVTV
	NTFTV
	NFTV
Crestron	CLS-EXP-DIMFLV
	DIN-4DIMFLV4
	DIN-A08
	GLX-DIMFLV8

NOTES:

Wiring diagrams are examples of typical installations intended to illustrate the number of wires that must be run to fixture. These diagrams are not intended to specify all equipment necessary for a given dimming circuit. Refer to specific dimmer manufacturer's documentation for details.

**EL2- EldoLED DRIVER
0-10V DIMMING**

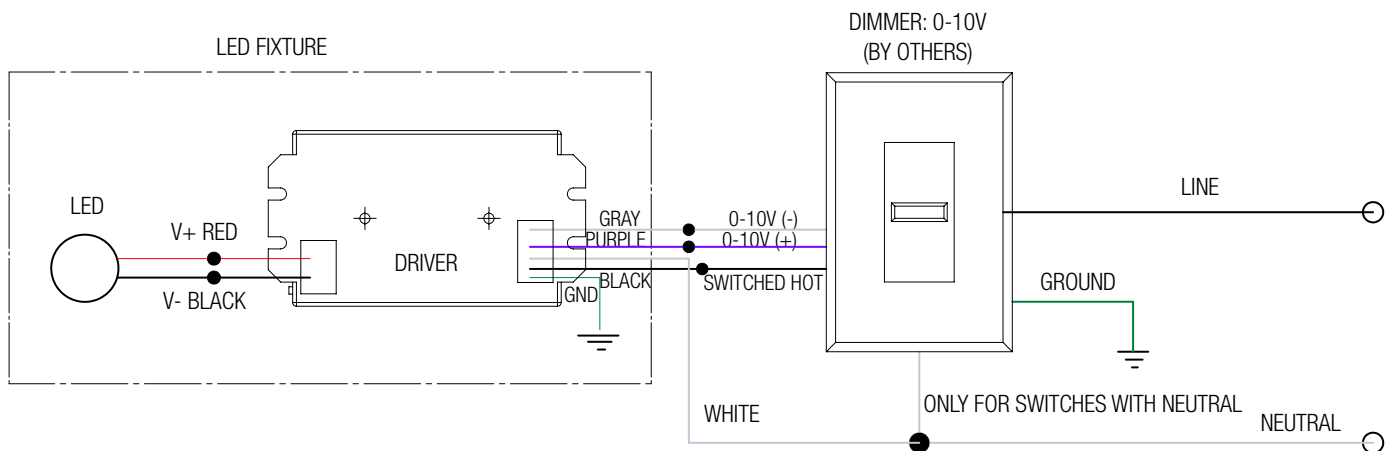

IMPORTANT SAFETY INSTRUCTIONS

- SAVE THESE INSTRUCTIONS

1. Keep these instructions in a safe place for future reference.
2. Only qualified electricians in accordance to local codes should install these fixtures.
3. De-energize the electrical circuit at the circuit breaker prior to installation process or servicing.
4. Make sure all connections are in accordance with the National Electrical Code and any local regulations.
5. Cap any wires not used separately (not together).

DIMMING DRIVER COMPATIBILITY

DIMMER LIST

"DMX" Moons	
Manufacturer	Product
	DMX Controls

NOTES:

Wiring diagrams are examples of typical installations intended to illustrate the number of wires that must be run to fixture. These diagrams are not intended to specify all equipment necessary for a given dimming circuit. Refer to specific dimmer manufacturer's documentation for details.

DMX- MOONS DRIVER DMX DIMMING

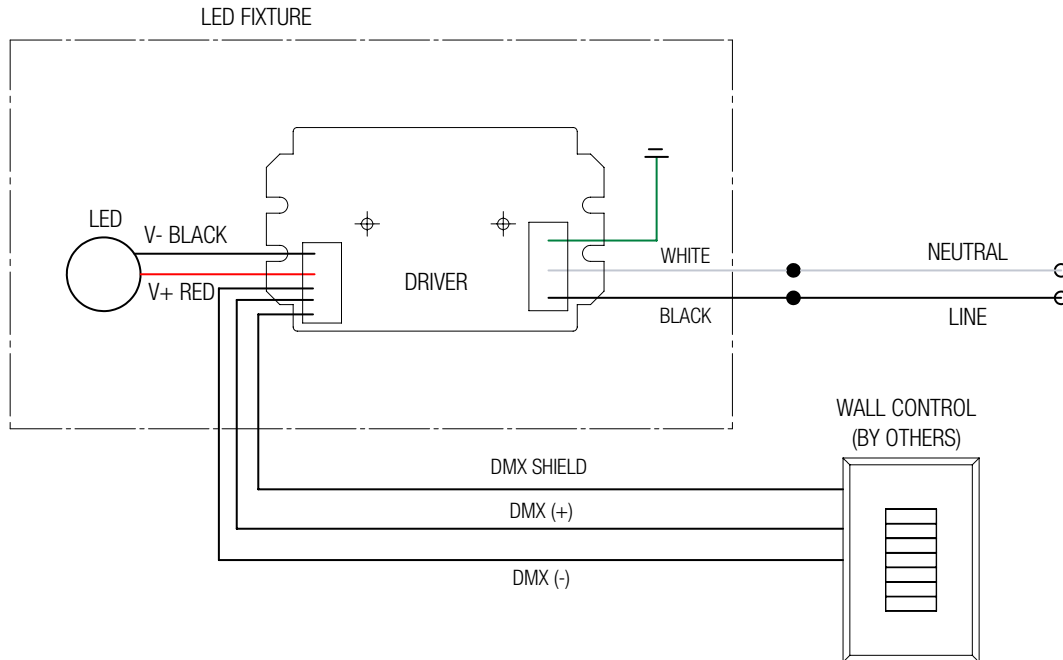

IMPORTANT SAFETY INSTRUCTIONS

- SAVE THESE INSTRUCTIONS

1. Keep these instructions in a safe place for future reference.
2. Only qualified electricians in accordance to local codes should install these fixtures.
3. De-energize the electrical circuit at the circuit breaker prior to installation process or servicing.
4. Make sure all connections are in accordance with the National Electrical Code and any local regulations.
5. Cap any wires not used separately (not together).